

DS-1227ZJ-DM32

In-Ceiling Mounting Bracket for Dome Camera



Features

- Steel and plastic material with surface spray treatment
- Magnetic design facilitates dome camera installation
- In-ceiling mounting saves installation space

Dimension

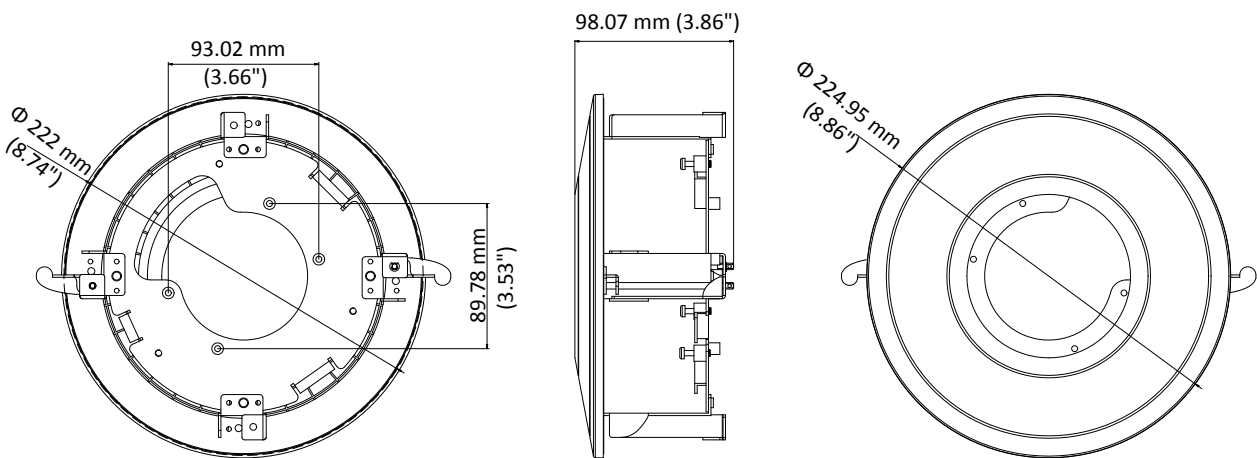

* Φ 222 mm (Φ 8.86") is the diameter for the cable hole on the ceiling.

Available Model

DS-1227ZJ-DM32

Parameters

Model	DS-1227ZJ-DM32
Parameters	In-Ceiling Mounting Bracket for Dome Camera
Appearance	Hikvision White
Material	Steel and Plastic
Dimension	Φ 224.95 mm \times 98.07 mm (Φ 8.86" \times 3.86")
Weight	660 g (1.46 lb.)

Notes

- The bracket should be installed on the flat ceiling.
- The ceiling must be capable of supporting over 3 times as much as the total weight of the camera and the bracket.
- The bracket's maximum load capacity is 3 Kg (6.6 lb.).